



FEATURES

- Universal 85 - 277VAC or 120 - 390VDC Input voltage
- Wide adjustable output voltage range
- Accepts AC or DC input (dual-use of same terminal)
- Operating ambient temperature range: -40°C to +85°C
- High efficiency, high reliability
- Active PFC
- High I/O isolation test voltage up to 4000VAC
- Supports 7+1 parallel redundancy
- Supports PMBus communication
- Output short circuit, over-current, over-voltage, over-temperature protection
- 5 years warranty
- Operating altitude up to 5000m
- Comply with IEC/EN/UL/BS EN62368, UL60601, GB4943

LMF3000-20Bxx series is one of Mornsun's enclosed AC-DC switching power supply. It features universal AC input and at the same time accepts DC input voltage, cost-effective, low no load power consumption, high efficiency, high reliability and double or reinforced insulation. These converters offer excellent EMC performance and meet IEC/EN61000-4, CISPR32/EN55032, IEC/EN/UL/BS EN62368, UL60601, GB4943, standards and they are widely used in areas of industrial, LED, street light control, electricity, security, telecommunications, medical, smart home etc.

Selection Guide

Part No.	Output Power (W)	Nominal Output Voltage and Current (Vo/Io)		Adjustable Range of Output Voltage Vo1(V)		Efficiency 230VAC (%) Typ.	Maximum Capacitive Load at normal temperature (µF)	
		Vo1/Io1	Vo2/Io2	ADJ	Vprog		Vo1	Vo2
LMF3000-20B24	3010	24V/125A	12V/0.8A	18-30	4.8-30	92	20000	470
LMF3000-20B48	3010	48V/62.5A	12V/0.8A	36-60	9.6-60	93	10000	470

Input Specifications

Item	Operating Conditions	Min.	Typ.	Max.	Unit
Input Voltage Range	Rated input (Certified voltage)	100	--	240	VAC
	AC input	85	--	277	
	DC input	120	--	390	VDC
Input Voltage Frequency	Rated input (Certified voltage)	47	--	63	Hz
	AC input	47	--	63	
Input Current	Rated input (Certified voltage)	--	--	20	A
	115VAC	--	--	16.5	
	230VAC	--	--	17.5	
Inrush Current	115VAC	Cold start	--	20	--
	230VAC		--	40	--
Power Factor	115VAC	Normal temperature, full load	PF ≥ 0.99		
	230VAC		PF ≥ 0.95		
Start-up Delay Time	115VAC/230VAC, normal temperature, rated load	--	--	3	s
Input Fuse	Built-in fuse	--	25	--	A
Input Under-voltage Protection	Under-voltage protection start (Input voltage drops from high to low)	60	--	--	VAC
	Under-voltage protection release (Input voltage rises from low to high)	--	--	85	
Hot Plug		Unavailable			

Output Specifications

Item	Operating Conditions		Min.	Typ.	Max.	Unit
Output Voltage Accuracy	Full load range		--	±1	--	%
Line Regulation	Rated load		--	±0.5	--	
Load Regulation	0% - 100% load		--	±0.5	--	
Minimum Load			0	--	--	
Ripple & Noise*	Vo1	24V	--	--	150	mV
		48V	--	--	250	
	Vo2	--	--	100		
Temperature Coefficient			--	±0.03	--	%/°C
Hold-up Time	115VAC/230VAC, rated load		--	14	--	ms
Short Circuit Protection			Long-term constant current without triggering over-temperature protection, self-recover after the short-circuit state is canceled			
Over-current Protection			Enter the constant current state, self-recover after the over-current state is canceled			
Over-voltage Protection	24V		≤35VDC (Output voltage turn off, re-power on for recover)			
	48V		≤70VDC (Output voltage turn off, re-power on for recover)			
Over-temperature Protection	230VAC, 100% load	Over-temperature protection start	--	--	65	°C
		Over-temperature protection release	50	--	--	

Note: *The "Tip and barrel method" is used for ripple and noise test, output parallel 47uF electrolytic capacitor and 0.1uF ceramic capacitor, please refer to Enclosed Switching Power Supply Application Notes for specific information.

General Specifications

Item	Operating Conditions		Min.	Typ.	Max.	Unit		
Isolation Test	Input - ⊕	Electric strength test for 1min., leakage current <10mA	2000	--	--	VAC		
	Input - output		4000	--	--			
	Output - ⊕		1500	--	--			
Insulation Resistance	Input - ⊕	Ambient temperature: 25 ± 5°C Relative humidity: < 95%RH, no condensation Test voltage: 500VDC	100	--	--	MΩ		
	Input - output		100	--	--			
	Output - ⊕		100	--	--			
Isolation level	Input - output		2 x MOPP					
	Input - ⊕		1 x MOPP					
	Output - ⊕		1 x MOPP					
Operating Temperature			-40	--	85	°C		
Storage Temperature			-40	--	85			
Operating Humidity	Non-condensing		10	--	95	%RH		
Storage Humidity			20	--	90			
Switching Frequency	PFC		--	65	--	KHz		
	DC-DC		--	82	--			
	Auxiliary source		--	65	--			
Power Derating	Operating temperature derating		-40°C to +50°C		0	--	% / °C	
			+50°C to +85°C		2.5	--		
	Input voltage derating	AC Input	85VAC-90VAC (Based on 1500W)		6	--	--	% / VAC
			90VAC-180VAC		1500			
			180VAC-277VAC		3000			
	DC Input	120VDC-180VDC (Based on 1500W)		1.25	--	--	% / VAC	
180VDC-350VDC		1500			W			

		350VDC-390VDC	3000
Leakage Current	240VAC, 60Hz	Touch current	<0.1mA
		Earth leakage current	<0.5mA
Safety Standards		Design refer to IEC/EN/UL/BS EN62368-1, UL60601-1, GB4943.1	
Safety Class		CLASS I	
MTBF	MIL-HDBK-217F@25°C	≥250,000 h	
Warranty	Ambient temperature: ≤85°C	5 years	

General Specifications

Case Material	Metal (SUS 304)
Dimensions	279.40mm x 177.80mm x 63.50mm
Weight	3400g (Typ.)
Cooling Method	Forced cooling 26.63 CFM

Electromagnetic Compatibility (EMC)

Emissions	CE	CISPR32 EN55011	CLASS A
	RE	CISPR32 EN55011	CLASS A
	Harmonic current	IEC/EN61000-3-2	CLASS A and CLASS D
Immunity*	ESD	IEC/EN61000-4-2 Contact ±8KV/Air ±15KV	Perf. Criteria A
	RS	IEC/EN61000-4-3 10V/m	
	EFT	IEC/EN61000-4-4 ±4KV	
	Surge	IEC/EN61000-4-5 line to line ±2KV/line to ground ±4KV	
	MS	IEC/EN61000-4-8 30A/m	
	CS	IEC/EN61000-4-6 0.15 - 80MHz 10Vr.m.s	
	Voltage dips	IEC/EN61000-4-11 0%, 70%	Perf. Criteria B

Note: *perf. Criteria:

A: The equipment shall continue to operate as intended without operator intervention;

B: After the test, the equipment shall continue to operate as intended without operator intervention;

C: Loss of function is allowed, provided the function is self-recoverable, or can be restored by the operation of the controls by the user in accordance with the manufacturer's instructions.

Functional Specifications

Item	Operating Conditions		Min.	Typ.	Max.	Unit
Remote Control Switch	All input voltage range, all load range	Power on	PS_ON /OFF(JP1300 Pin1) and SGND (JP1300 Pin2) are short			
		Power off	PS_ON/OFF (JP1300 Pin1) and SGND (JP1300 Pin2) are open			
DC-OK Signal	All input voltage range, all load range	Power on	--	0	0.5	V
		Power off	10	--	12	
Current Sharing Accuracy	Output >50%Io1		--	±10	--	%
Remote Sense	The total compensated voltage value of Vs+ and Vs- (Pin12 and Pin18 of the JP1300) when they are shorted to both ends of the output load (Vs+ to +Vo, Vs- to -Vo) respectively		--	200	--	mV
Oring			Support direct parallel use, achieve 7+1 parallel redundancy			
LED Signal	Main output status indication	Normal output	Green on			
		Abnormal output, protected	Red on			
		Power off (AC without Input)	Light off			
SDA, SCL for I ² C			Internal 2.4 kΩ pull-up resistor to internal 3.3V			

Product Characteristic Curve

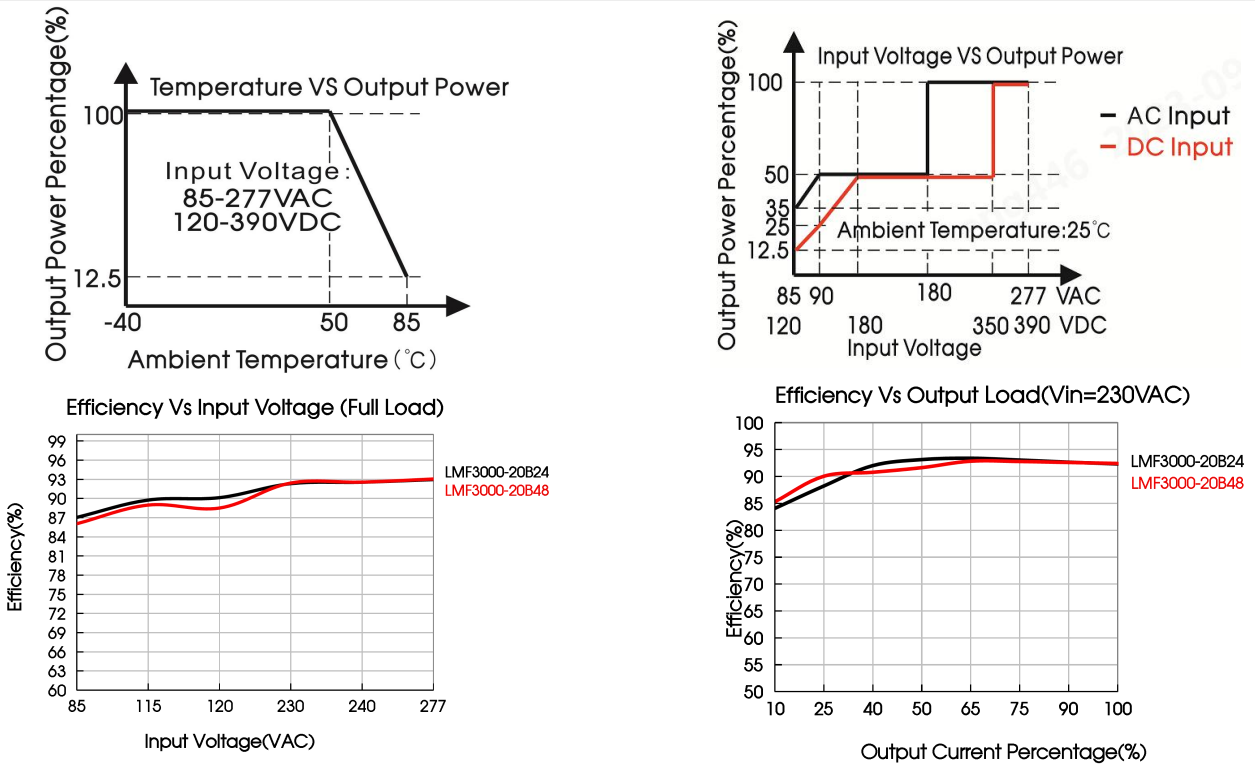

Dimensions and Recommended Layout

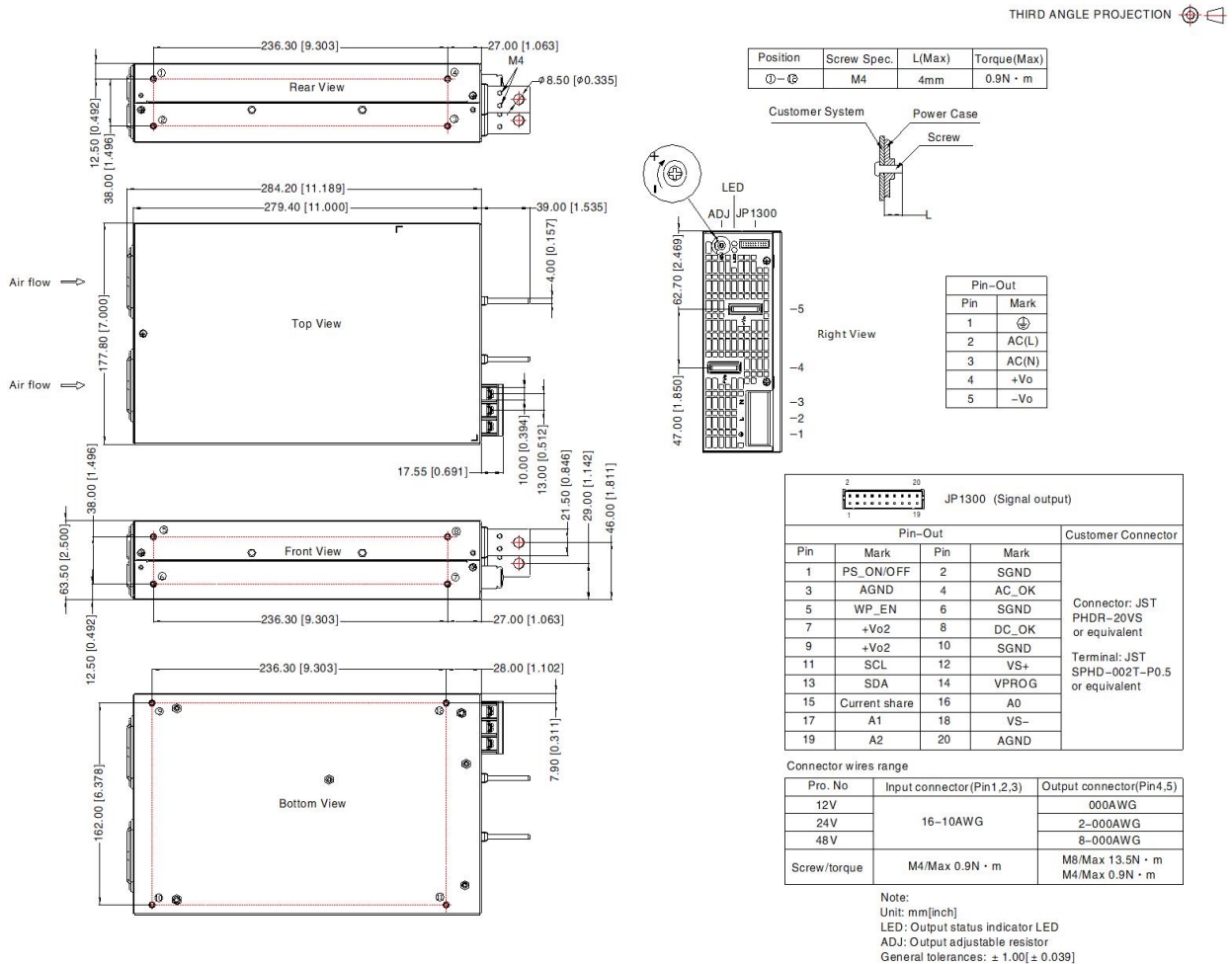

Note:

1. For additional information on Product Packaging please refer to www.mornsun-power.com. Packaging bag number: 58220625
2. Unless otherwise specified, parameters in this datasheet were measured under the conditions of $T_a=25^{\circ}\text{C}$, humidity <75%RH with nominal input voltage and rated output load;
3. The room temperature derating of $5^{\circ}\text{C}/1000\text{m}$ is needed for operating altitude greater than 2000m;
4. All index testing methods in this datasheet are based on our company corporate standards;
5. In order to improve the efficiency at high input voltage, there will be audible noise generated, but it does not affect product performance and reliability;
6. We can provide product customization service, please contact our technicians directly for specific information;
7. Products are related to laws and regulations: see "Features" and "EMC";
8. The out case needs to be connected to PE (\perp) of system when the terminal equipment in operating;
9. The output voltage can be adjusted by the ADJ, clockwise to increase;
10. Our products shall be classified according to ISO14001 and related environmental laws and regulations, and shall be handled by qualified units;
11. The power supply is considered a component which will be installed into a terminal equipment. All EMC tests should be confirmed with the final equipment. Please consult our FAE for EMC test operation instructions.

Mornsun Guangzhou Science & Technology Co., Ltd.

Address: No. 5, Kehui St. 1, Kehui Development Center, Science Ave., Guangzhou Science City, Huangpu District, Guangzhou, P. R. China
Tel: 86-20-38601850 Fax: 86-20-38601272 E-mail: info@mornsun.cn www.mornsun-power.com

LMF3000-20Bxx Power Supply Application Note

Content

1. Overview description.....	7
1.1 AC/DC input terminal block (J1).....	8
1.2 Main DC output terminal (+Vo, -Vo).....	8
1.3 Auxiliary DC output terminal (+Vo2: Pin7, 9; SGND: PIN2, 6, 10).....	9
1.4 Signal port (JP1300).....	9
1.5 Green and red status display LED lights.....	10
1.6 Output voltage adjustment knob.....	10
2. Function Manual.....	11
2.1 Input requirements.....	11
2.2 Output requirements.....	11
2.3 Start-up timing.....	11
2.4 Fan speed control.....	12
2.5 Output over-voltage protection (OVP).....	12
2.6 Output constant-current protection (OCP).....	13
2.7 Output short circuit protection (SCP).....	13
2.8 Over-temperature protection (OTP).....	13
2.9 Output power derating.....	13
2.10 Remote control.....	14
2.11 DC_OK signal.....	14
2.12 Remote compensation.....	15
2.13 Parallel operation.....	16
2.13.1 Redundancy.....	16
2.13.2 Current sharing.....	16
2.14 PMBus communication address.....	19
3. Installation requirements.....	20
3.1 Safety introduction.....	20
3.2 Safety requirements.....	20
3.3 Installation method.....	20
4. Communication protocol.....	22

1. Overview description

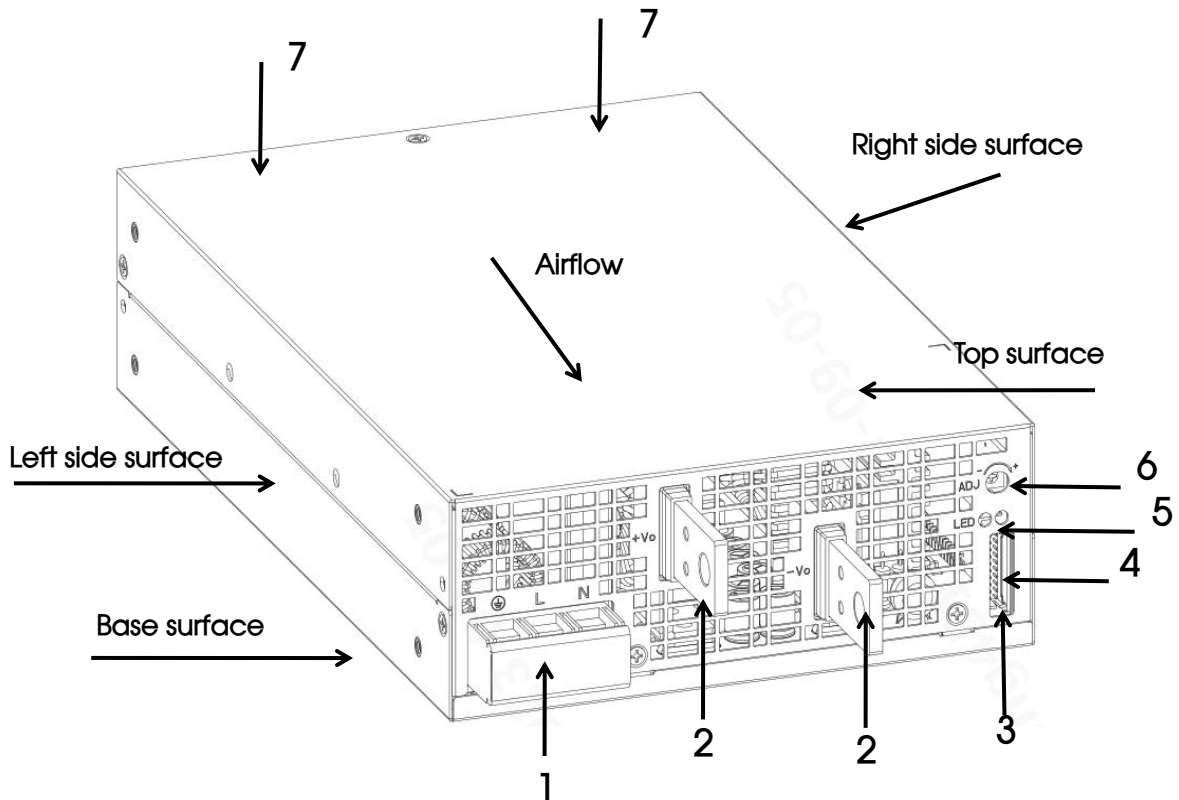

Fig. 1: Appearance information of LMF3000-20Bxx

Overview description:

1. AC/DC input terminal (J1)
2. DC main output terminal (+Vo, -Vo)
3. Auxiliary output terminal (JP1300 +Vo2: PIN7, 9; SGND: PIN2, 6, 10)
4. Signal connection press the terminal (JP1300)
5. Green and red status display LED lights
6. Output voltage regulation resistor
7. Fans

1.1 AC/DC input terminal block (J1)

The input terminal J1, as a standard 3-pin fence welding terminal with upper cover, the center spacing of the pins is 13mm.

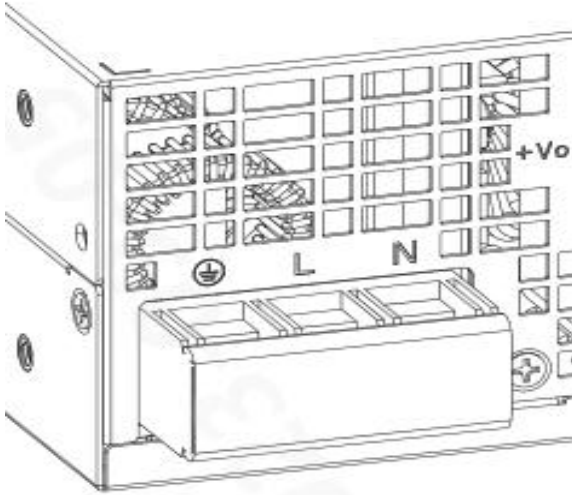

Pin	Features
L	Line (Phase)
N	Neutral
	Ground/Earth

Wire size: 16-10AWG
Torque: M4/0.9N·m (max)

1.2 Main DC output terminal (+Vo, -Vo)

The output terminal uses two standard screw lock type metal terminals, the pin spacing between each is 45mm.

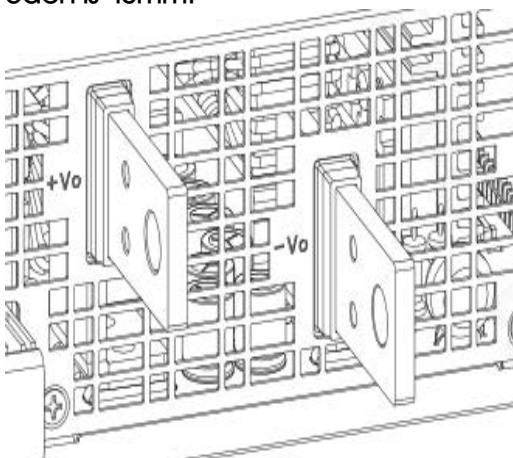

Pin	Features
+Vo	Main output +
-Vo	Main output -

Torque: M8/13.5N·m (max)
M4/0.9N·m (max)

1.3 Auxiliary DC output terminal (+Vo2: Pin7, 9; SGND: PIN2, 6, 10)

The auxiliary output terminal with a standard terminal of 2.0mm pitch.

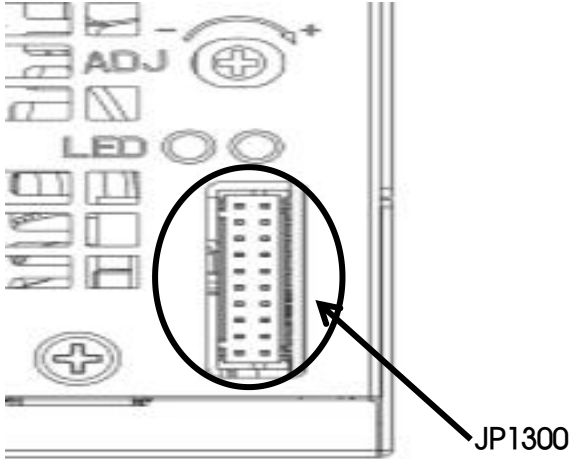

Pin	Label	Function
Pin7, 9	+Vo2	Auxiliary DC output +
PIN2, 6, 10	SGND	Auxiliary DC output -

1.4 Signal port (JP1300)

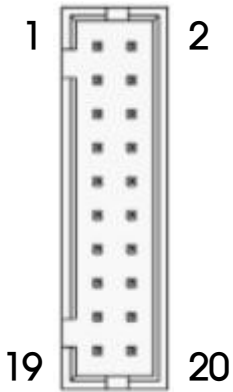

Pin	Label	Features
1	PS_ON/OFF	Remote control signal
2	SGND	AUX terminal reference ground
3	AGND	Signal terminal reference ground
4	AC_OK	AC_OK Signal
5	WP-EN	External storage enable signal
6	SGND	AUX terminal reference ground
7	+Vo2	The auxiliary path outputs the positive terminal
8	DC_OK	DC_OK Signal
9	+Vo2	The auxiliary path outputs the positive terminal
10	SGND	AUX terminal reference ground
11	SCL	I2C communication line
12	VS+	Remote compensation positive terminal
13	SDA	I2C communication line
14	VPROG	The software output is adjustable
15	Current share	Current sharing bus
16	A0	ADDRESS code 0
17	A1	ADDRESS code 1
18	VS-	Remote compensation negative terminal
19	A2	ADDRESS code 2
20	AGND	Signal terminal reference ground

Note: The reference ground of all pins on the signal terminal is Pin2, Pin6 and Pin10.

1.5 Green and red status display LED lights

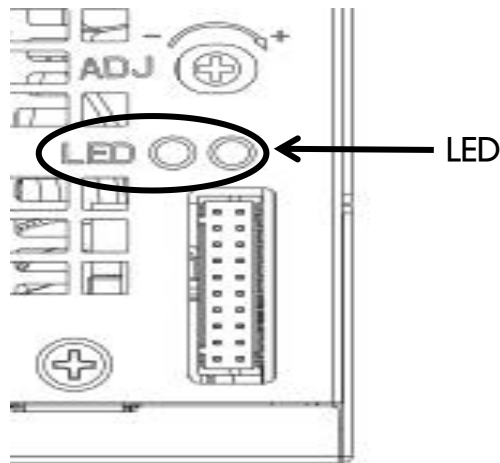

Two kinds of LED lights indicate difference working states of the power supply:

Green LED	Red LED	Status
ON	OFF	Normal work
OFF	ON	Main alarm
OFF	OFF	No input

1.6 Output voltage adjustment knob

Turn counterclockwise to increase output voltage

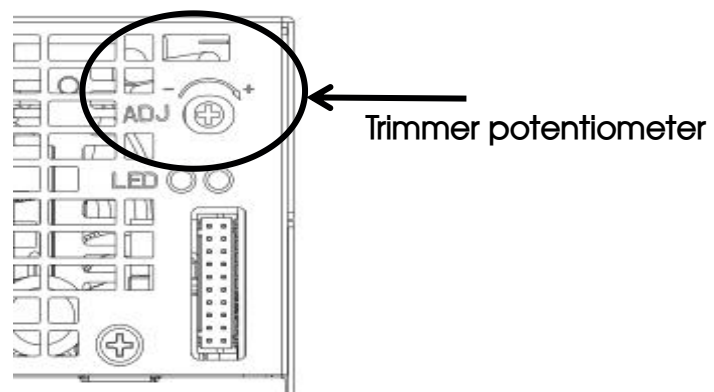

Model	Rated Output Voltage	Adjustable Range Of Output Voltage
LMF3000-20B24	24V	18-30V
LMF3000-20B48	48V	36-60V

2. Function Manual

2.1 Input requirements

The AC input voltage and DC input voltage must be within the defined voltage range (refer to data-sheet), otherwise the power supply may not work properly or even malfunction. The internal L and N line of the power module have been connected in series with a 250V 25A fuse. For better protection, it is recommended that customers use a circuit breaker not greater than 25A (Non-mandatory requirement).

2.2 Output requirements

Main output

At any voltage value, the maximum output current and power must not exceed the rated/specified value. The output current must not exceed the maximum output current value.

Auxiliary output

The auxiliary circuit supports a maximum current of 12V/0.8A.

2.3 Start-up timing

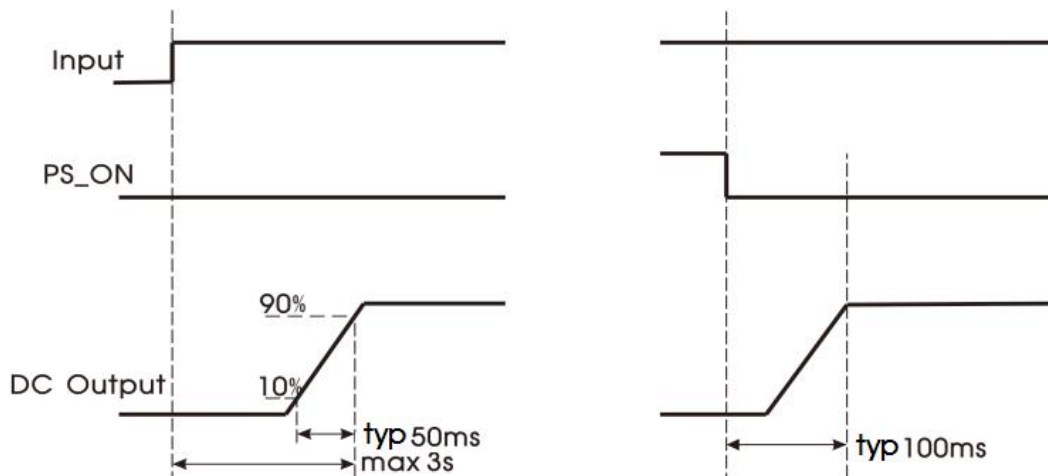

Item	Operating Conditions		Min.	Typ.	Max.	Unit
Power-off Hold Time	Room temperature, full load	115VAC	14	--	--	ms
		230VAC	14	--	--	
Start Delay Time	230VAC, full load, 25°C		--	--	3	s

2.4 Fan speed control

Fan speed is determined by output power and output voltage at the same time, refer to the following curve for fan speed change.

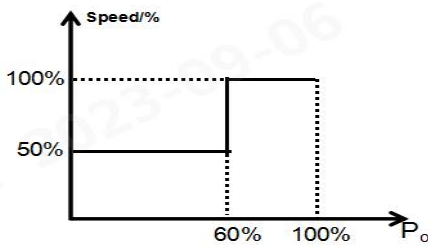

Fig.1

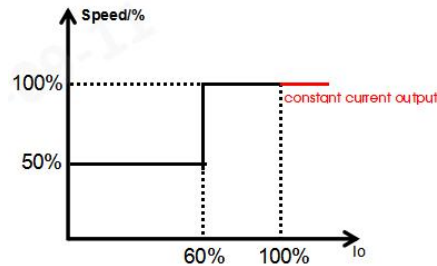

Fig.2

Po/Io: Rated output voltage

2.5 Output over-voltage protection (OVP)

Main output

The over-voltage protection function is to close the main output when the output voltage reaches the protection voltage value. When the main circuit over-voltage protection occurs, the main circuit output voltage of the module will be shut off, and the auxiliary circuit output will not be affected. The main circuit output can be restored after disconnecting the input power for at least 3 seconds.

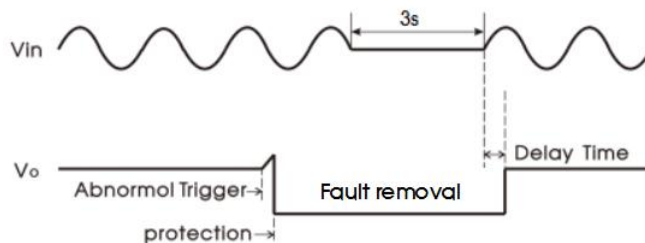

In addition, it can be quickly restarted by the PS_ON signal:

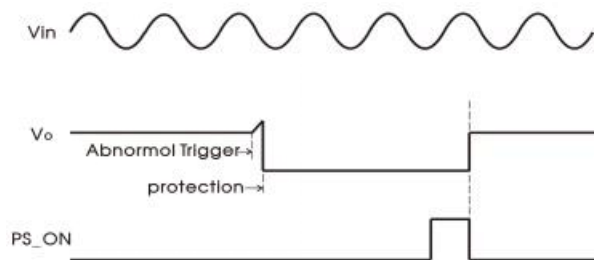

Auxiliary output

When the auxiliary circuit voltage reaches 16VDC (maximum value), the auxiliary output will be in hiccup status, and the main output voltage will be in hiccup status until the auxiliary output returns to normal after the fault is eliminated.

2.6 Output constant-current protection (OCP)

① Main circuit overcurrent

If in CC load mode, when the current exceeds the constant current point, the output enters CC mode; when the over current state is released, the output returns to normal.

If in CV/CR load mode, the relationship among output current, voltage and resistance is shown in the following curve:

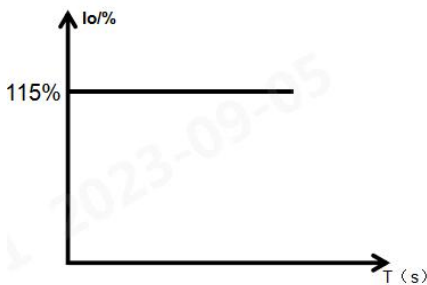

Fig.1

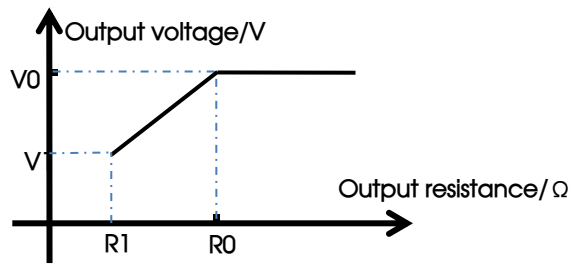

Fig.2

When the product enters the constant current state (The over-temperature protection is not triggered), the output state circulates as shown in Fig.1, until the constant current state is released. In Fig.2, the corresponding slope of segments R1-R0 is the corresponding output current I when the current is constant.

② Auxiliary circuit overcurrent

When the auxiliary output current exceeds 130% (typ.) of the rated current, turn off the main output. After the overflows state is removed, the main route automatically recovers output after restart.

2.7 Output short circuit protection (SCP)

When the main output is short-circuited, the power output in CC mode (The over-temperature protection is not triggered). Fig.1 shows 2.6, after the short-circuit is removed, the power module will automatically return to normal, and the auxiliary output will not be affected.

When the auxiliary circuit output is short-circuited, the main circuit without output.

2.8 Over-temperature protection (OTP)

When the ambient temperature of the power supply exceeds the rated temperature for a period of time, the power supply will be turned off and the power supply will resume normal operation after the ambient temperature drops to the set value.

2.9 Output power derating

When the input voltage is greater than 180VAC (or 350VDC), only need to derate according to the

temperature derating curve.

When the input voltage is lower than 180VAC (or 350VDC), the output power will be derated according to the following input voltage derating curve after temperature derating.

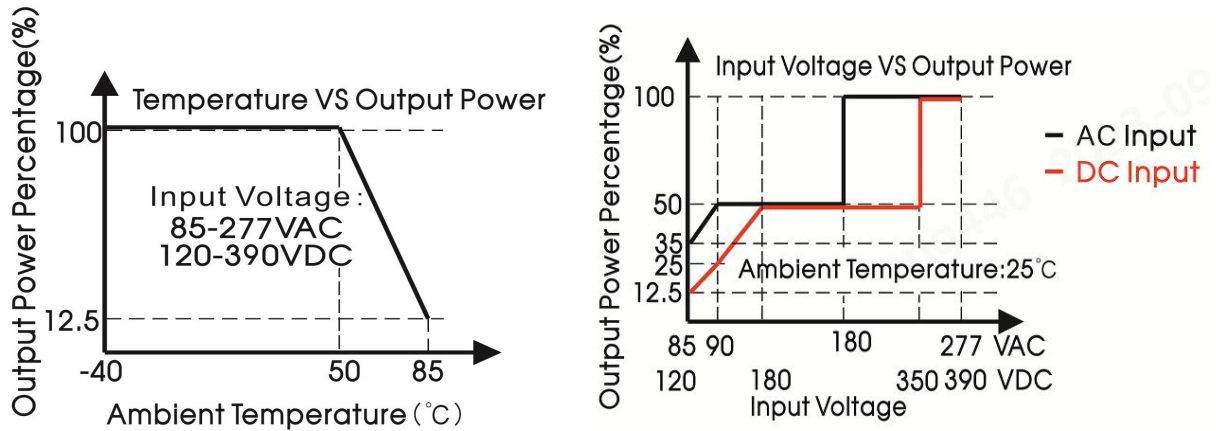

2.10 Remote control

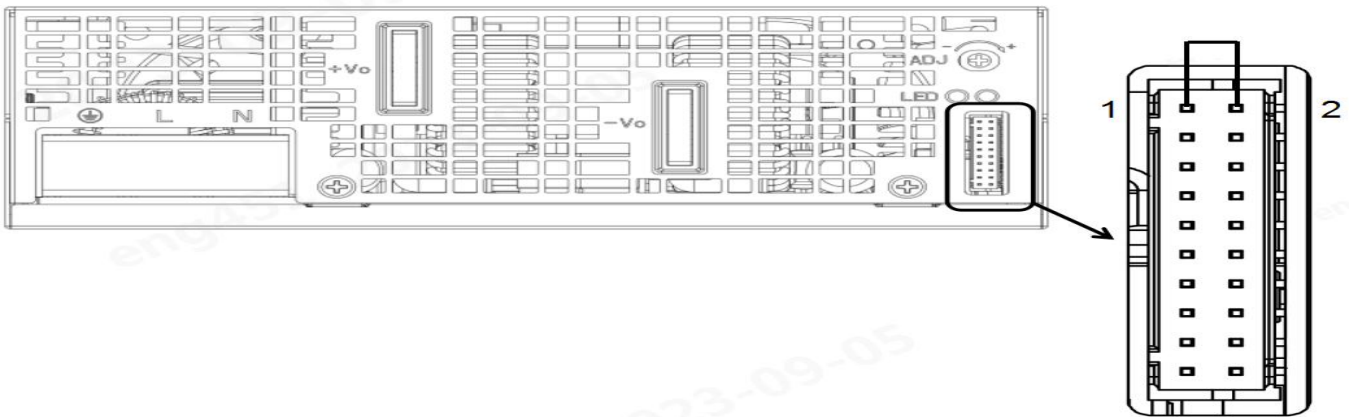

Switch between PS_ON/OFF (Pin1) and SGND (Pin2)	Output Status
Short-Circuit	Output on
Pin floating	Output off

If the input terminal of the power module has been connected to a power source, the PS_ON/OFF signal pin can be used to control the on and off of the main output, and the PS_ON/OFF signal does not affect the output voltage of the auxiliary circuit.

Note: The internal PS_ON/OFF input impedance of the module is 5.1K.

2.11 DC_OK signal

The DC_OK signal is used to monitor whether the power supply is working normally, and the signal is at Pin8 of the signal terminal JP1300.

Note: When the DC_OK signal is connected to the external circuit, the impedance of the external external

circuit (between Pin8 and Pin2, 6, 10 of JP1300) is not less than 10k Ω .

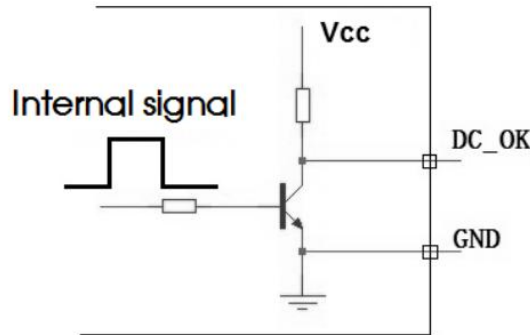
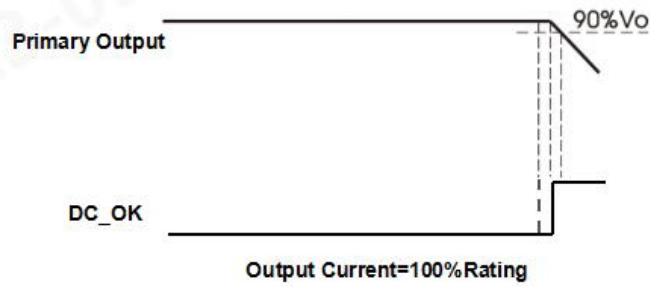

DC_OK (Pin8) and SGND (Pin2, 6, 10)	Output State
0 - 0.5V	Output on
10 - 12V	Output off

2.12 Remote compensation

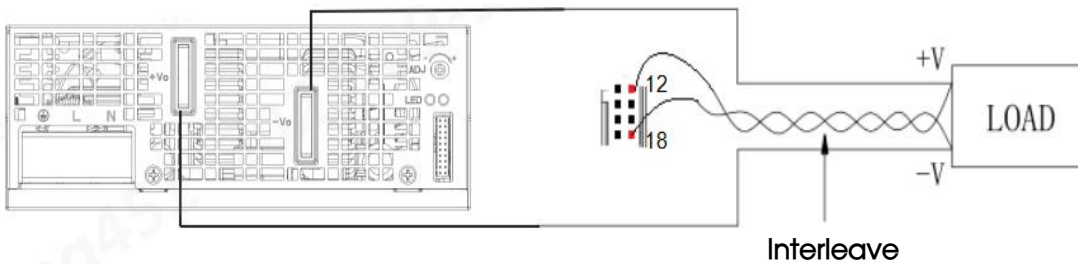

Note:

1. Vs+ and Vs- cannot be shorted or reversed, otherwise the power module will be damaged.
2. Before powering on the product, please confirm whether the control signal connection terminal (JP1300) Pin1 (PS_ON/OFF) and Pin2 (SGND) short-circuit jumper cap are connected. If not, the product without output. When the control signal connection terminal (JP1300) of the product are external connected as a whole, please ensure that Pin1 and Pin2 are short-circuit connected. Please refer to LMF3000-20Bxx Series Power Supply Application Notes: 2.10 Remote control.
3. Pin 12 and pin 18 of the signal terminal JP1300 can compensate the voltage drop on the output cable.

4. The remote compensation circuit can compensate 200mV cable voltage drop. This voltage includes the sum of the cable drop connected to the output positive terminal and the output negative terminal.

5. If you need to use the remote compensation function, the signal pin needs to be connected with the load end with a twisted pair cable.

2.13 Parallel operation

2.13.1 Redundancy

The power module output can be connected in parallel to achieve redundancy, thereby improving system reliability. The maximum power of the redundant system needs to be derated to ensure that the redundant system can still meet the rated load requirements when a power supply module fails. The current common practice is to construct a redundant system by the N+1 method, that is, N+1 power supplies are connected in parallel, to support the maximum load current $N \cdot I_{\text{omax}}$, where I_{omax} is the rated output current of each power supply. For example, the rated output current of each power supply is 40A, and 7+1 units are connected in parallel to construct a $7 \cdot 40\text{A} = 120\text{A}$ redundant system.

The power module supports 7+1 parallel redundant operation.

2.13.2 Current sharing

Method 1: Current sharing bus and remote compensation lines are both connected.

For load line loss $\leq 200\text{mV}$, and the output voltage difference of each single module $\leq 50\text{mV}$, this type of connection is recommended to obtain a better line-end output voltage and current sharing effect.

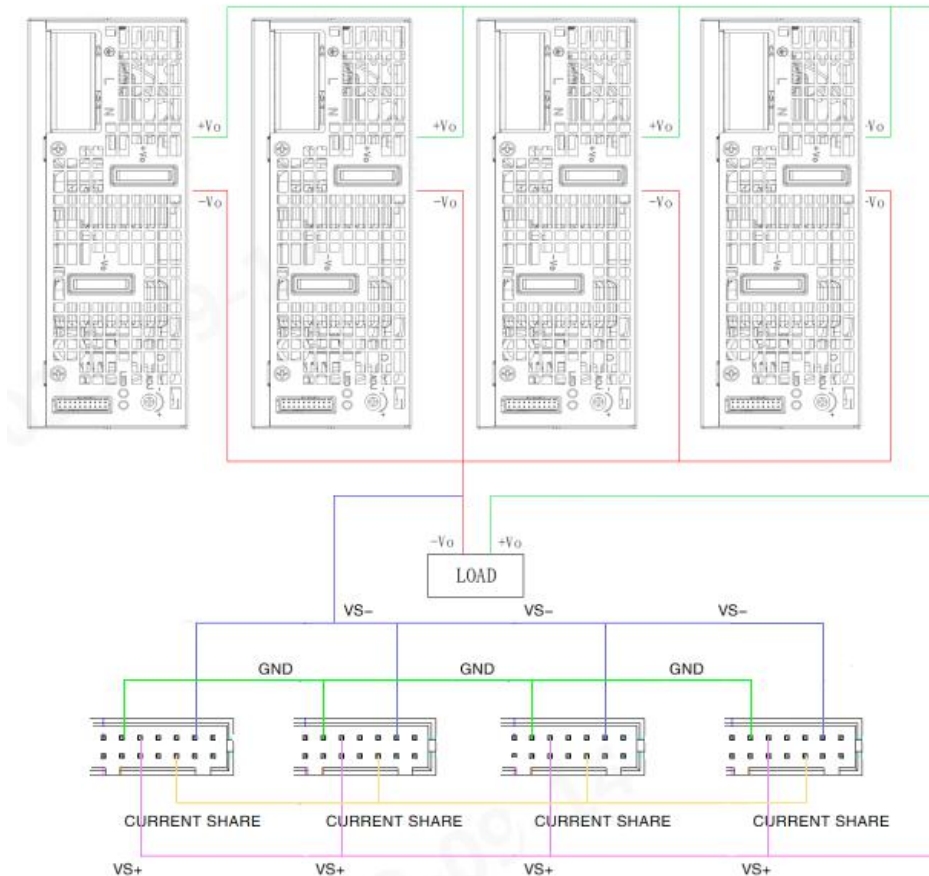

Method 2: Only the current sharing bus is connected, and the remote compensation is not connected.

For the load line loss $\geq 200\text{mV}$, or the output voltage difference of each single module cannot or does not need to be accurately adjusted to $\leq 50\text{mV}$, this type of connection is recommended to obtain a better current sharing effect of the parallel machine. In the same way, when the load loss is unknown or the current sharing fails to meet the specifications under the first connection method, it is recommended to replace it with this connected method. The wiring method of the current sharing function is shown in the figure below:

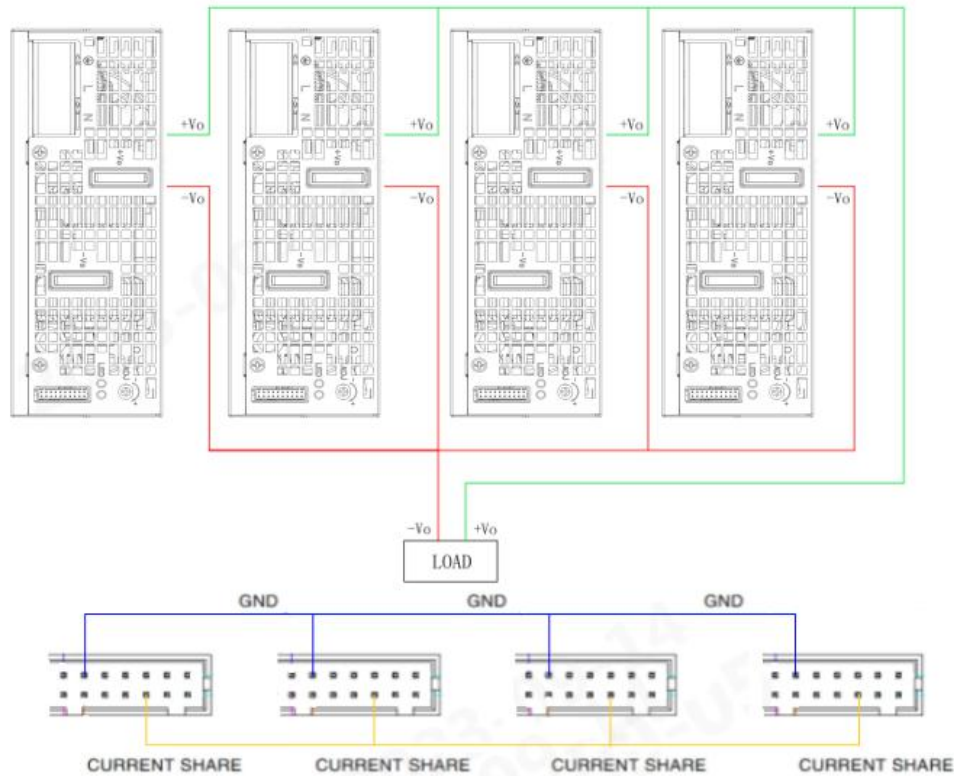

Note: 1. When using in parallel, the number of parallel modules cannot exceed 8.

2. Before powering on the product, please confirm whether the control signal connection terminal (JP1300) Pin1 (PS_ON/OFF) and Pin2 (SGND) short-circuit jumper cap are connected. If not, the product without output. When the control signal connection terminal (JP1300) of the product are external connected as a whole, please ensure that Pin1 and Pin2 are short-circuit connected. Please refer to LMF3000-20Bxx Series Power Supply Application Notes: 2.10 Remote control.

When power modules work in parallel, there is an internal active current sharing circuit to ensure that the current between each module is balanced.

The active current sharing circuit adopts the automatic master-slave current sharing method. Each power module has a current sharing bus signal (CURRENT SHARE BUS). When working in parallel, the current sharing bus of all power modules must be connected together. The current-sharing bus signal is located at pin 15 of JP1300.

The output voltage of each power module will affect the current sharing accuracy. The output voltage of the power module is the rated voltage $\pm 50\text{mV}$. In practical applications, if the output voltage value needs to be adjusted, the output voltage of all parallel power supply modules needs to be adjusted to the same voltage. The recommended voltage range: target voltage value $\pm 50\text{mV}$

After the output load of each power module is greater than 50% of the rated load, the current sharing accuracy should be $\pm 10\%$. The current sharing calculation formula is:

$$\text{Current sharing accuracy} = \frac{I_{o \max} - I_{o \min}}{I_{o \max}} * 100\%$$

$I_{o \max}$: the maximum output current value in parallel power supply modules.

$I_{o \min}$: the minimum output current value in parallel power supply modules.

2.14 PMBus communication address

In the parallel system, if you need to identify the power module information, you need to set the PMBus communication address for each parallel power module, and exchange data with the host computer through I2C. The setting of the communication address is determined by pins 16, 17 and 19 of the signal terminal JP1300. When these three pins are short-circuited with pin 3 or 20 of JP1300, it will be low level (L, voltage range: 0 - 1.31V). When disconnected, it is high level (H, voltage range: 1.99V - 3.3V). The specific address number is shown in the table below:

ADDRESS 2	ADDRESS 1	ADDRESS 0	Address number
L	L	L	0
L	L	H	1
L	H	L	2
L	H	H	3
H	L	L	4
H	L	H	5
H	H	L	6
H	H	H	7

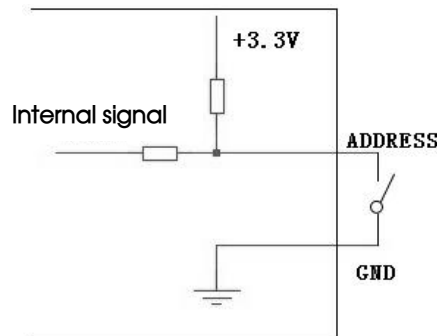

The internal pull-up resistance value of the power module is $10k\Omega$, and the external impedance can be matched according to the actual application to meet the high and low voltage range.

3. Installation requirements

3.1 Safety introduction

Warning: Risk of electric shock

During high voltage operating

- The power supply module is disconnected from the input DC or the AC power and placed for at least one minute before starting to operate it.
- When installing the input wire to the power module, please connect the ground terminal first, and then connect the L line and the N line.
- When removing the input wire, please remove the L wire and the N wire first, and then remove the ground wire.
- When disassembling, make sure that no objects fall into the power module.
- Pay attention to high temperature.
- After the power module is working in a high temperature environment, wait for its shell to cool down before operating.
- This product needs to be installed by professionals and needs to be used with other equipment.

3.2 Safety requirements

When installing, pay attention to the primary side and the protective ground, the creep distance and the electrical clearance of the primary side and the secondary side refer to EN60601-1.

3.3 Installation method

Standard mounting orientation:

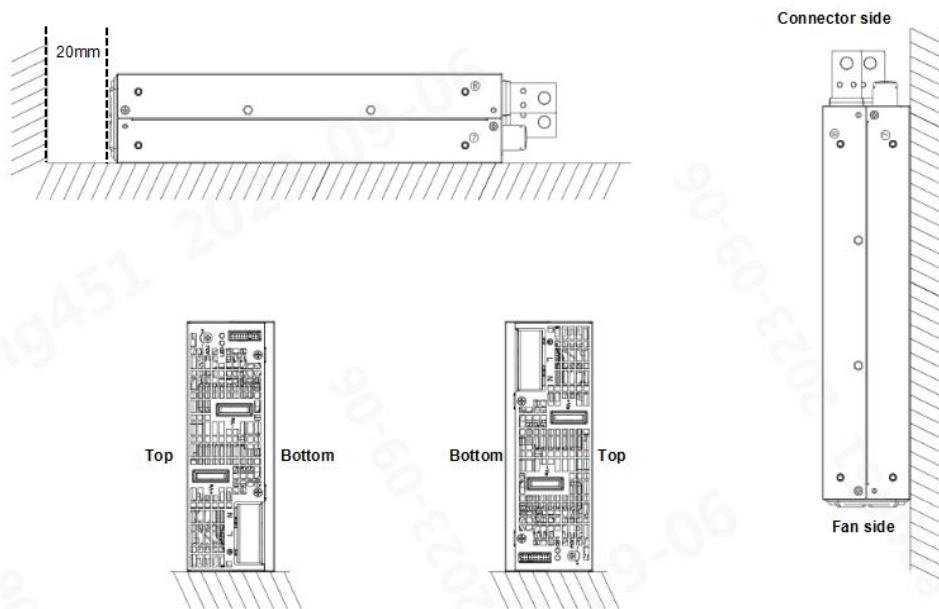

Position of mounting holes:

THIRD ANGLE PROJECTION

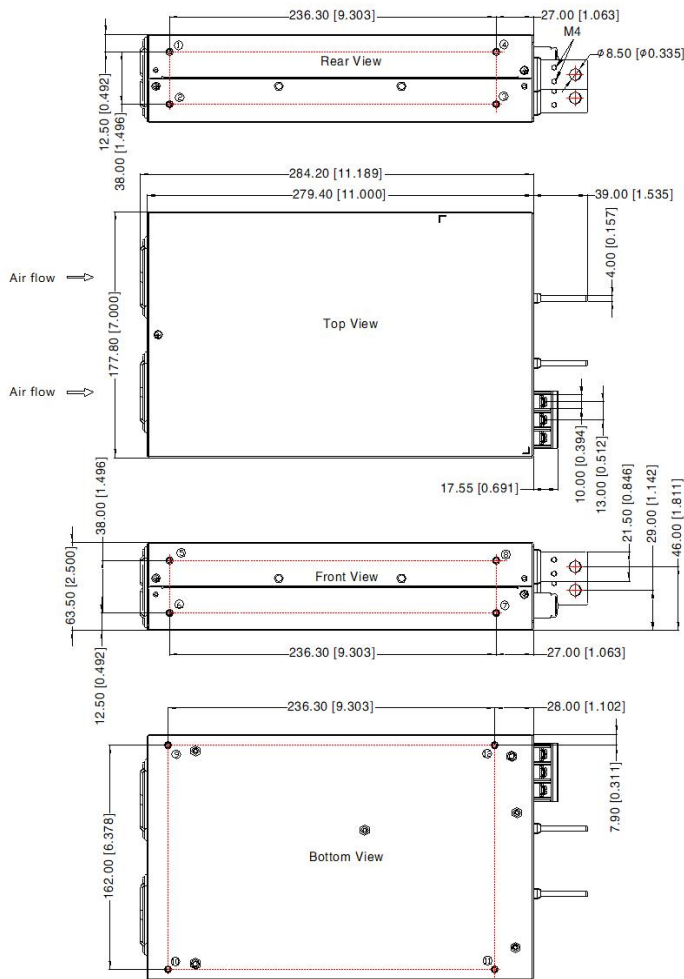

Position	Screw Spec.	L(Max)	Torque(Max)
①-③	M4	4mm	0.9N · m

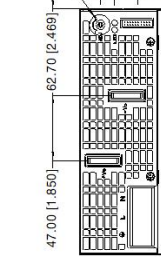
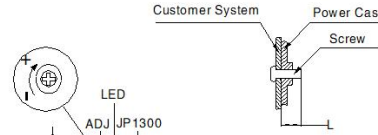

Pin-Out	
Pin	Mark
1	AC(L)
3	AC(N)
4	+Vo
5	-Vo

JP1300 (Signal output)				Customer Connector
Pin-Out		Mark		
Pin	Mark	Pin	Mark	Connector: JST PHDR-20VS or equivalent Terminal: JST SPHD-002T-P0.5 or equivalent
1	PS_ON/OFF	2	SGND	
3	AGND	4	AC_OK	
5	WP_EN	6	SGND	
7	+Vo2	8	DC_OK	
9	+Vo2	10	SGND	
11	SCL	12	VS+	
13	SDA	14	VPROG	
15	Current share	16	A0	
17	A1	18	VS-	
19	A2	20	AGND	

Connector wires range

Pro. No	Input connector(Pin1,2,3)	Output connector(Pin4,5)
12V	16-10AWG	000AWG
24V		2-000AWG
48V		8-000AWG
Screw/torque	M4/Max 0.9N · m	M8/Max 13.5N · m M4/Max 0.9N · m

Note:
 Unit: mm[inch]
 LED: Output status indicator LED
 ADJ: Output adjustable resistor
 General tolerances: ± 1.00[± 0.039]

Note: The fan panel cannot be blocked by other objects, and a distance of at least 20mm must be maintained, otherwise it will affect the heat dissipation and performance of the power module.

4. Communication protocol

The LMF3000-20Bxx series power modules support standard PMBus communication protocols and manage and monitor the power modules through I2C bus.

command	command name	Data read and write type	data byte	default	data layout	Command description
00h	PAGE	Read Byte	1	00h		Reads the currently selected Page index number(0-Page0 corresponding main channel)
01h	OPERATION	Read/Write Byte	1	80h		This command is used to remotely switch on and off the system. The alarm is cleared once when the system starts. 0x80: power on; 0x40: power off;
02h	ON_OFF_CONFIG	Read/Write Byte	1	1Ch		Output The default value of the on-off control feature: 0x1D Bit4: 0-Is the power module powered on at any time regardless of the status of the control pin 1-The power module is not powered on before the pin control and command operation (set in bit 3:0)Bit3: 0-Ignore the CMD command word of the bus to start and stop the power module 1-According to the bus start command, the power module starts the output. According to the bit 2, the power module needs to set the control pin for the power module to start the output Bit2: 0-Power module ignore control pin (Power module switch is controlled only by CMD command) 1-The power module starts after the control pin is installed.According to bit 3, you need to run the command power module to start output. Bit1: 0-Active low level (start output with low power module) 1-Active high level (high power module to start output) Bit0: reserved
03h	CLEAR_FAULTS	Send Byte	0		N/A	This command is used to clear the current Page fault. After receiving this command, the existing fault alarms can be cleared. This command can only be cleared for all page faults
10h	WRITE_PROTECT	Read/Write Byte	1	80h		This command is used to control write operations on the PMBus device 0x80: All write operations except the 10h command are prohibited 0x40: All write operations except 10h, 00h, and 01h commands are prohibited 00: Enables the write operation of all writable commands
15h	STORE_USER_ALL	Send Byte	0		N/A	Copy the entire contents of the running memory into non-volatile storage memory

19h	CAPABILITY	Read Byte	1	A0h		Communication capability query command Bit7: PEC verification 0– PEC is not supported 1– PEC is supported Bit6 to Bit5: indicates the maximum bus rate 00– Maximum bus speed,100KHz 01– Maximum bus speed,400KHz Bit4: Smbaler #: 0– The smbaler # alarm signal is not supported 1– Support Smbaler # alarm signal Bit3 to Bit0: reserved
20h	VOUT_MODE	Read Byte	1	17h	Linear16	Output related data format definition 0x17: The data representing the output voltage is in Linear16 format, with Q=-9 data format
21h	VOUT_COM MAND	Read/Write Byte	2	24.0	Linear16	Set the output voltage to the LINEAR16 data format, Q=-9 The value ranges from 0 to 24
35h	VIN_ON	Read Byte	2	70.0	Linear11	Input voltage Start value
36h	VIN_OFF	Read Byte	2	60.0	Linear11	Input voltage protection value
3Ah	FAN_CONFI G_1_2	Read Byte	1	99h		Fan configuration Bit7: Indicates whether Position1 has a fan 0 - No fan. 1 - No fan Bit6: Format of the fan speed control command 0 - duty cycle (default), 1 - RPM, Bit5 - 4: Speed is measured in pulses per second, bit4=1, bit5=0 Bit3: Indicates whether Position2 has a fan 0 - No fan. 1 - No fan Bit2: Format of the fan speed control command 0 - duty cycle (default), 1 - RPM, Bit1 - 0: The speed is measured in pulses per second
3Bh	FAN_COMM AND_1	Read/Write Word	2	0	Linear11	Fan speed control command, percentage control, LINEAR11 data format The set speed is higher than the speed required by the power supply
40h	VOUT_OV_F AULT_LIMIT	Read Byte	2	34.0	Linear16	The output overvoltage protection point of the power module is Linear16 and Q=-9
41h	VOUT_OV_F AULT_RESPON SE	Read Byte	1	0xB8		Output overvoltage protection response: 3.5s restart
42h	VOUT_OV_W ARN_LIMIT	Read Byte	2	32.0	Linear16	The value of the power module output overvoltage alarm is Linear16, with Q=-9
46h	IOUT_OC_FA ULT_LIMIT	Read Byte	2	175.0	Linear11	Power module output overcurrent protection point
47h	IOUT_OC_FA ULT_RESPON SE	Read Byte	1	0xF8		Output overcurrent protection response: 3.5s restart
4Fh	OT_FAULT_LI	Read Byte	2	119.0°C	Linear11	Power module overtemperature

	MIT					protection point
50h	OT_FAULT_RESPONSE	Read Byte	1	0xC0		Power module overtemperature protection response: Restart the power module after overtemperature recovery
51h	OT_WARN_LIMIT	Read Byte	2	116.0°C	Linear11	The power module overtemperature warning point is LINEAR11 data format
68h	POUT_OP_FAULT_LIMIT	Read Byte	2	3600.0	Linear11	Output overload protection point of the power module
69h	POUT_OP_FAULT_RESPONSE	Read Byte	1	0xF8		Output overload protection Response: 3.5s restart
6Ah	POUT_OP_WARN_LIMIT	Read Byte	2	3450.0	Linear11	Power module output overload alarm
78h	STATUS_BYTE	Read Byte	1	00h		The low power status byte is mapped from status bytes such as STATUS_VOUT Bit7 reserved Bit6 OFF Bit5 VOUT_OV_FAULT Bit4 IOUT_OC_FAULT Bit3 reservation Bit2 TEMPERATURE Bit1 CML Bit0 reservation
79h	STATUS_WORD	Read Word	2	0000h		Power status double bytes, mapped by status bytes such as STATUS_VOUT Low byte Bit7 reserved Bit6 OFF Bit5 VOUT_OV_FAULT Bit4 IOUT_OC_FAULT Bit3 reservation Bit2 TEMPERATURE Bit1 CML Bit0 reservation High byte Bit7 VOUT Bit6 IOUT/POUT Bit5 reservation Bit4 MFRSPECIFIC Bit3 POWER_GOOD# Bit2 FANS Bit1 reservation Bit0 reservation
7Ah	STATUS_VOUT	Read/Write Byte	1	00h		The output voltage is related to the power supply. Write 1 Clear the alarm. If the fault persists, reset the power supply Bit7 VOUT_OV_FAULT Bit6 VOUT_OV_WARNING Bit5 reservation Bit4 reservation Bit3 reservation Bit2 reservation Bit1 reservation
7Dh	STATUS_TEMP	Read/Write Byte	1	00h		If the status is related to the temperature of the power supply, write 1. Clear the alarm. If the fault persists, reset the power supply Bit7 OTP_FAULT Bit6 OTP_WARNING Bit5 reservation Bit4 reservation

						Bit3 reservation Bit2 reservation Bit1 reservation Bit0 reservation
7Eh	STATUS_CML	Read/Write Byte	1	00h		If the status is related to the temperature of the power supply, write 1. Clear the alarm. If the fault persists, reset the power supply Bit7 OTP_FAULT Bit6 OTP_WARNING Communication, storage, or logic-related status Bit7 Invalid Or Unsupported Command Received Bit6 Invalid Or Unsupported Data Received Bit5 Packet Error Check Failed Bit4 reservation Bit3 reservation Bit2 reservation Bit1 reservation Bit0 reservation Bit5 reservation Bit4 reservation Bit3 reservation Bit2 reservation Bit1 reservation Bit0 reservation
80h	STATUS_MFR_SPECIFIC	Read/Write Byte	1			The status is defined by the power supply manufacturer
81h	STATUS_FANS_1_2	Read/Write Byte	1			1 Clear the alarm. If the fault persists, reset the fan module Bit7 Fan 1 Fault Bit6 Fan 2 Fault Bit5 reservation Bit4 reservation Bit3 reservation Bit2 reservation Bit1 reservation Bit0 reservation
88h	READ_VIN	Read Word	2		Linear11	Input voltage value, LINEAR11 data format
8Bh	READ_VOUT	Read Word	2		Linear16	Output voltage value, LINEAR16 data format, Q=-9
8Ch	READ_IOUT	Read Word	2		Linear11	Output current value, LINEAR11 data format
8Dh	READ_TEMPERATURE_1	Read Word	2		Linear11	Power side hot spot temperature, LINEAR11 data format
90h	READ_FAN_SPEED_1	Read Word	2		Linear11	Fan speed, unit: RPM, N=0, LINEAR11 data format
91h	READ_FAN_SPEED_2	Read Word	2		Linear11	Fan speed, unit: RPM, N=0, LINEAR11 data format
96h	READ_POUT	Read Word	2		Linear11	Output power value, LINEAR11 data format
98h	PMBUS_REVISION	Read Byte	1	22h		Indicates the PMBus version V1.2
99h	MFR_ID	Block Read	Var	MORNSUN	ASCII	Manufacturer code, ASCII character string, maximum 32 characters
9Ah	MFR_MODEL	Block Read	Var	LMF3000	ASCII	The value is an ASCII character string with a maximum of 32 characters
9Bh	MFR_REVISION	Block Read	Var	1.0	ASCII	Product version number. The value is a string of up to 32 ASCII characters

9Ch	MFR_LOCATION	Block Read	Var	WH	ASCII	The value is an ASCII character string with a maximum of 32 characters
9Dh	MFR_DATE	Block Read	10	2023-02-27	ASCII	The value is an ASCII character string with a maximum of 32 characters
9Eh	MFR_SERIAL	Block Read	Var	123456789	ASCII	Product serial number, ASCII string, maximum 32 characters

For more details, please consult the MORNSUN FAE.